

# DESCRIPTION

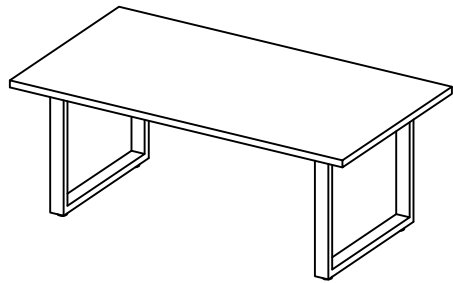



# ASSEMBLY INSTRUCTIONS



*homeville*

## Step 1

### HARDWARE

No.	Item	Detail	Quantity
1	X		x8
2	Y		x1
3	L1	 M8x20mm	x8
4	A		x1
5	B		x2

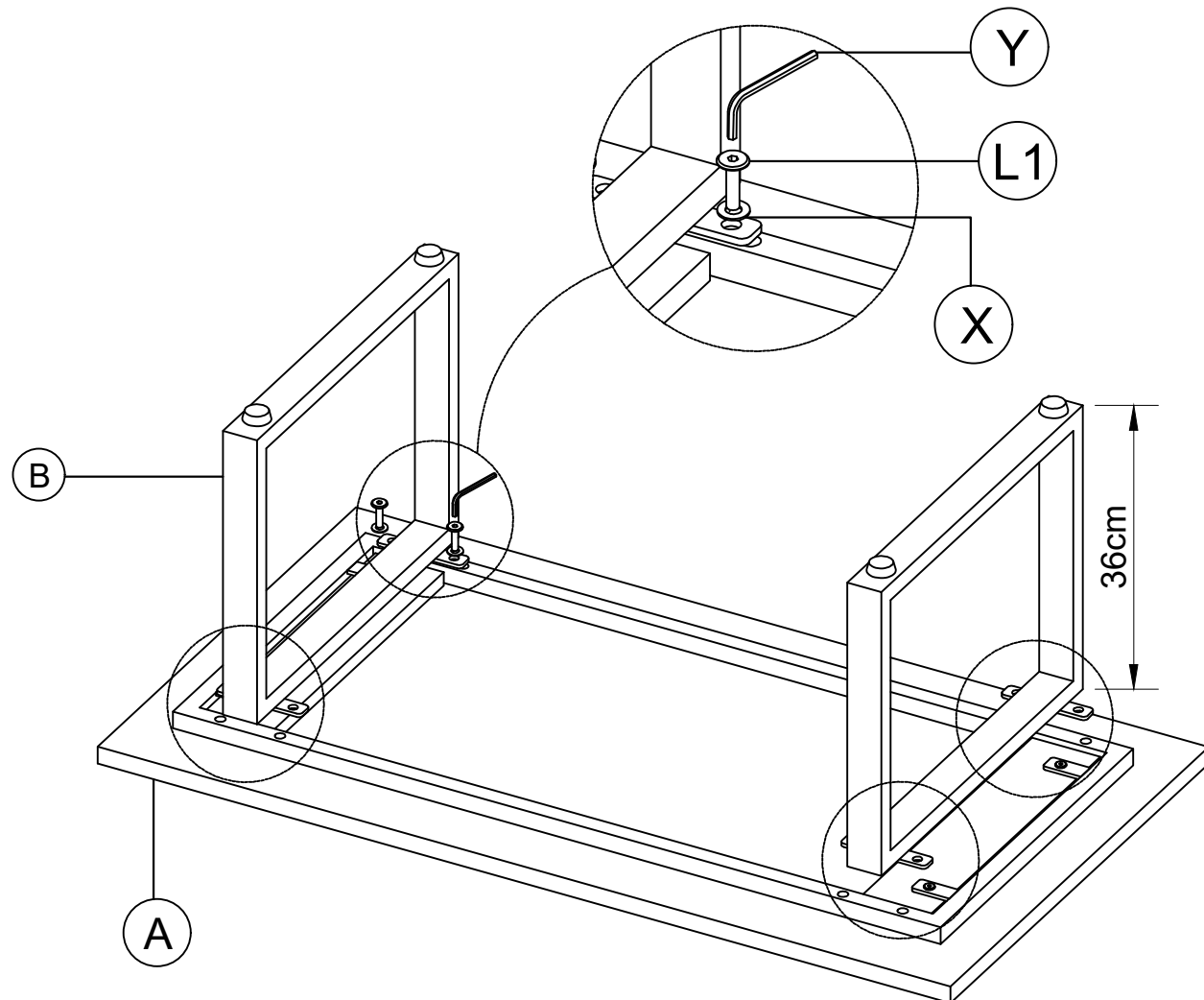

### IMPORTANT NOTE:

Do not tighten all screws/bolts until all completely assembled.  
Thank you.

# DESCRIPTION

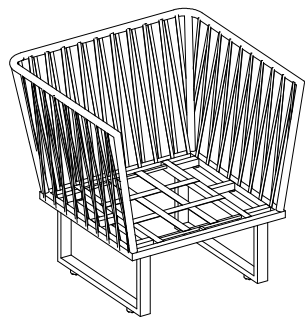



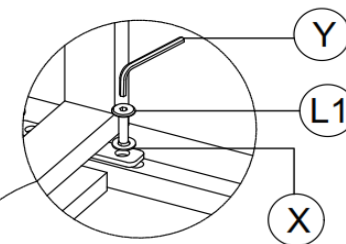

# ASSEMBLY INSTRUCTIONS

*homeville*

## Step 1



## HARDWARE

No.	Item	Detail	Quantity
1	X		x8
2	Y		x1
3	L1	 M8x20mm	x8
4	C		x1
5	D		x2

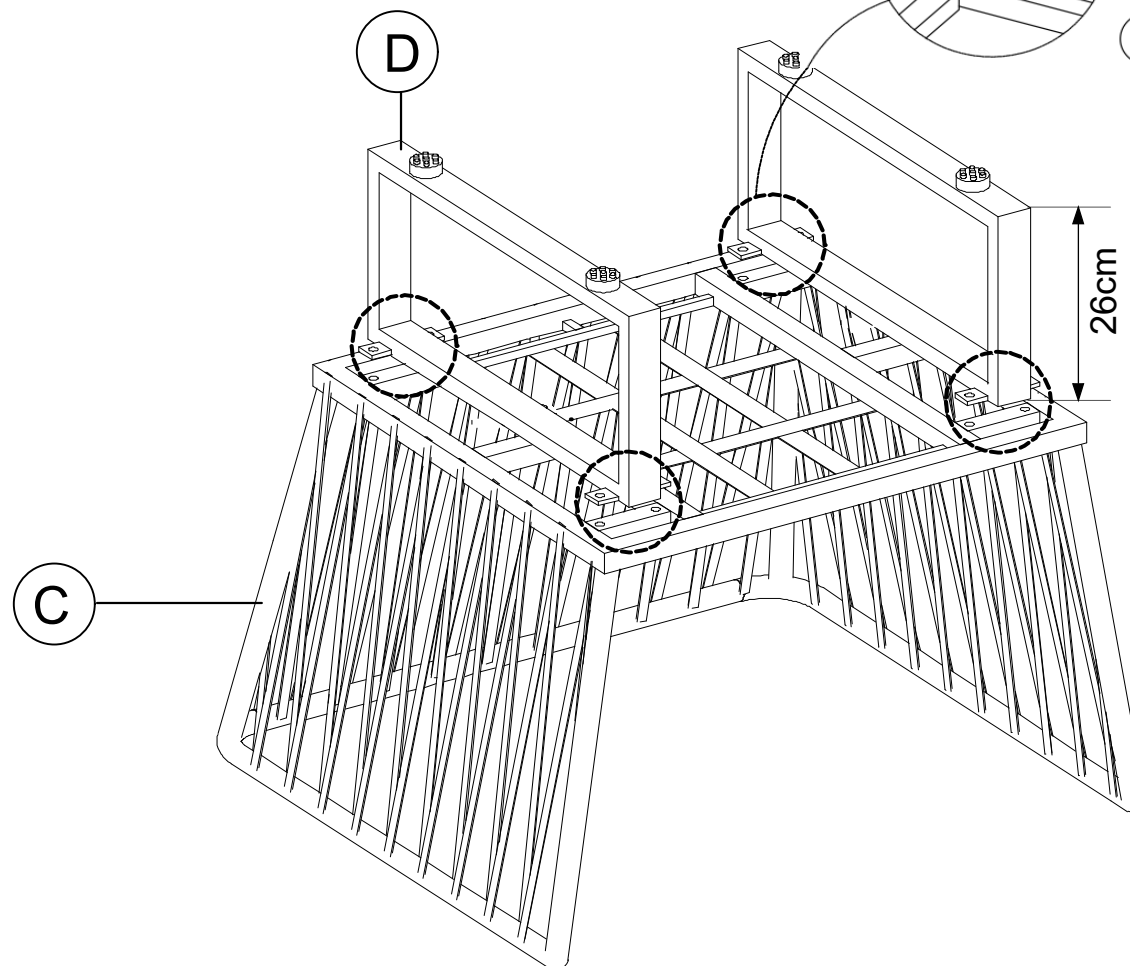

### IMPORTANT NOTE:

Do not tighten all screws/bolts until all completely assembled.

Thank you.

# DESCRIPTION

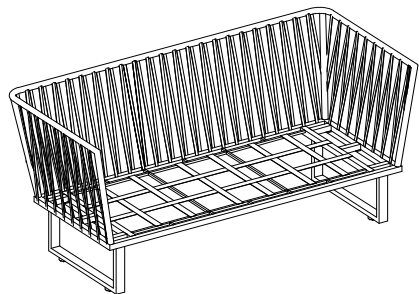



# ASSEMBLY INSTRUCTIONS

*homeville*

## Step 1

### HARDWARE

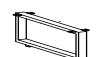
No.	Item	Detail	Quantity
1	X		x8
2	Y		x1
3	L1	 M8x20mm	x8
4	E		x1
5	D		x2

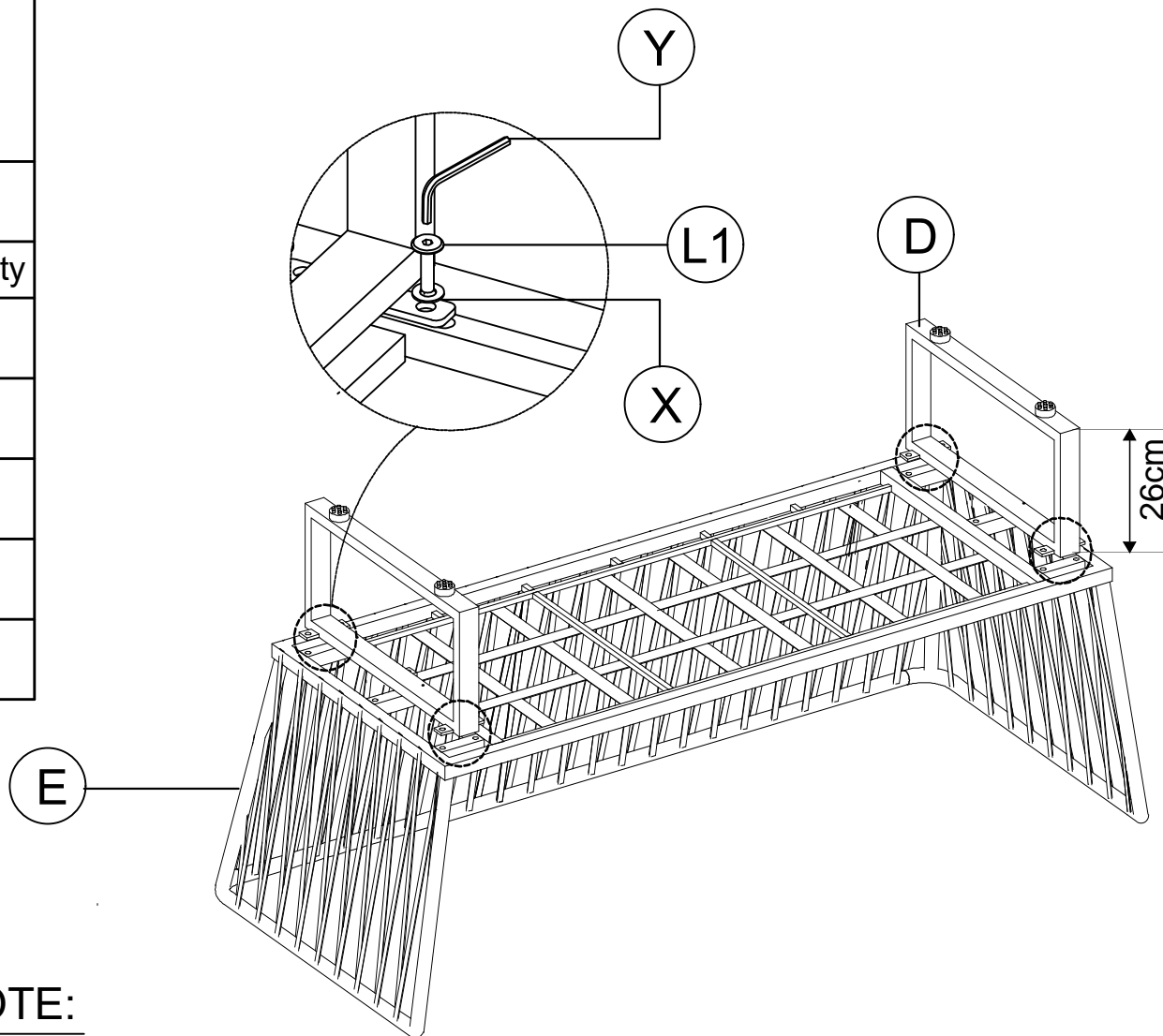

### IMPORTANT NOTE:

Do not tighten all screws/bolts until all completely assembled.  
Thank you.