



# Basketballstander LUX/LUX safe



 **WARNING**  
CHOKING HAZARD  
small parts  
Adult assembly required  
retain for future reference



## **Sikkerhedsadvarsel**

Læs alle instrukser og færdiggør samlingen før brug. Hvis basketballstanderen er samlet og bruges korrekt, kan den bruges til mange timers sjov og træning.

Tjek basketballstanderen før hvert brug. Hvis dele er slidte, i stykker eller manglende så udskift disse. Spænd dele der måtte være løse.

Hav altid opsyn af en voksen hvis børn benytter basketballstanderen.

Lad aldrig et barn klatre på basketballstanderen, da dette kan få den til at vælte og kan forårsage alvorlige skader på barnet.

**OBS!** Basketballstanderen kan vælte i blæsevejr.

Da rørene er elektrisk ledende, må elektriske dele aldrig komme i kontakt med basketballstanderen. Dette inkluderer bl.a. lamper, forlængerledninger og andet elektrisk udstyr.

## **Samlingsadvarsel**

Saml aldrig basketballstanderen i voldsomt regnvejr, blæst, storm eller lignende forhold.

Når basketballstanderen skal flyttes, bør mindst to personer løfte den og med en lige vægtfordeling. Placér basketballstanderen på en plan overflade ved ethvert brug.

Frigør pladsen omkring basketballstanderen, så der ikke hænger ledninger, grene eller er andre forhindringer i nærheden.

## **Vedligeholdelse**

Tjek basketballstanderen før hvert brug.

Følgende forhold kan potentielt udgøre fare:

1. Manglende, forkert eller usikker samling af basketballstanderen.
2. Hvis nettet er hullet, flosset eller ødelagt.
3. Bøjet eller brækket rør.
4. Udstikkende skarpe dele.
5. Løse eller manglende dele af basketballstanderen.

## Før samling af basketballstanderen

1. Der skal være 2 personer til at opsamle basketballstanderen.
2. Lad ikke basketballstanderen stå frit, før sandbasen er påfyldt med sand.
3. Brug ikke vand da dette vil sive ud af sandbasen.
4. Denne basketballstander er ikke godkendt til at "dunke" i.

## Indhold

**A**

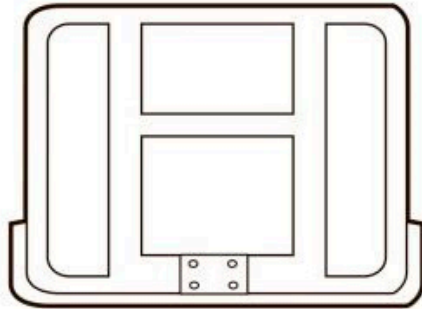

Bagplade 80016189

**B**



Kurv 801635  
Net 425824

**C**

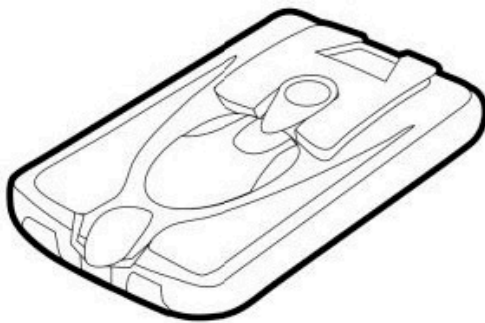

Sandbase 801624

**D**



Rør 801620

**F**



Rør 801621

**E**



Rør 801622

**G**



Supportstang X 2  
801623

**H**



Hjul 801674 X 2

**I**

Møtrik X 1  
Boltsæt 801629



**J**



Hjulaksel 801675

**K**



Support beslag 801625

**L**



Dæksel til topør  
Boltsæt 801629

**M**

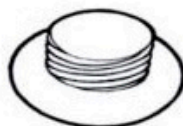





Dæksel til sandbase  
Boltsæt 801629

1x Beskyttelsespude





bestplay

(Medfølger kun til safe-modellen)



Boltsæt 801629

<p><b>N-1</b> M8</p>  <p>x6</p>	<p><b>N-2</b> M10</p>  <p>x3</p>	<p><b>O-1</b> M8</p>  <p>x16</p>	<p><b>O-2</b> M10</p>  <p>x6</p>
--	---	--	---

---

<p>M8 x16mm</p>  <p><b>1</b> x4</p>	<p>M8 x20mm</p>  <p><b>2</b> x2</p>	<p>M8 x40mm</p>  <p><b>3</b> x4</p>	<p>M10 x85mm</p>  <p><b>4</b> x1</p>
--	--	--	--



---

<p>M10 x90mm</p>  <p><b>5</b> x2</p>	<p>M8 x 90mm</p>  <p><b>6</b> x1</p>
---	--

---

Anbefalet værktøj



Uå• ÅÖa\^a\i}^Áa\i\^a\|c}^Á\Á  
 \^}Á\^a\}á^EÖ^çá^a^Áa\çá^Á  
 †|@|ÁÁ^\*}á^\*^i}^É

## Trin 1

1. Før hjulaksel (J) igennem de 2 hjul (H) og det nederste rør (D) på sandbasen (C).
2. Fastgør de 2 støttestænger (G) på det nederste rør (D) med bolte (1) og skiver (O-1).
3. Spænd derefter den anden ende af støttestængerne (G) fast i sandbasen (C) med bolte (2), skiver (O-1) og møtrikker (N-1).



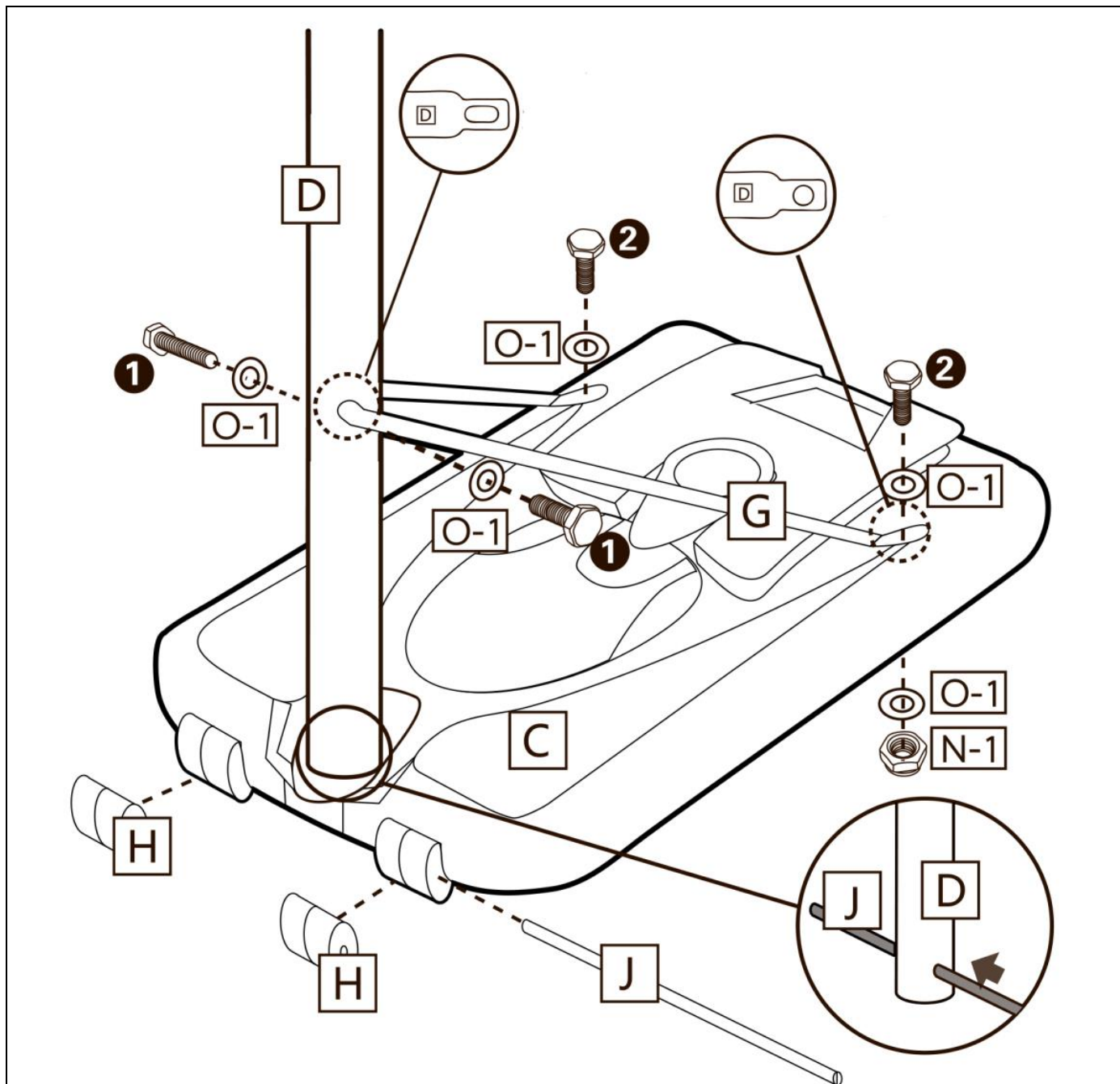

Trin 2

1. Fastgør support beslaget (K) og kurven (B) på bagpladen (A) med bolte (3), skiver (O-1) og møtrikker (N-1).

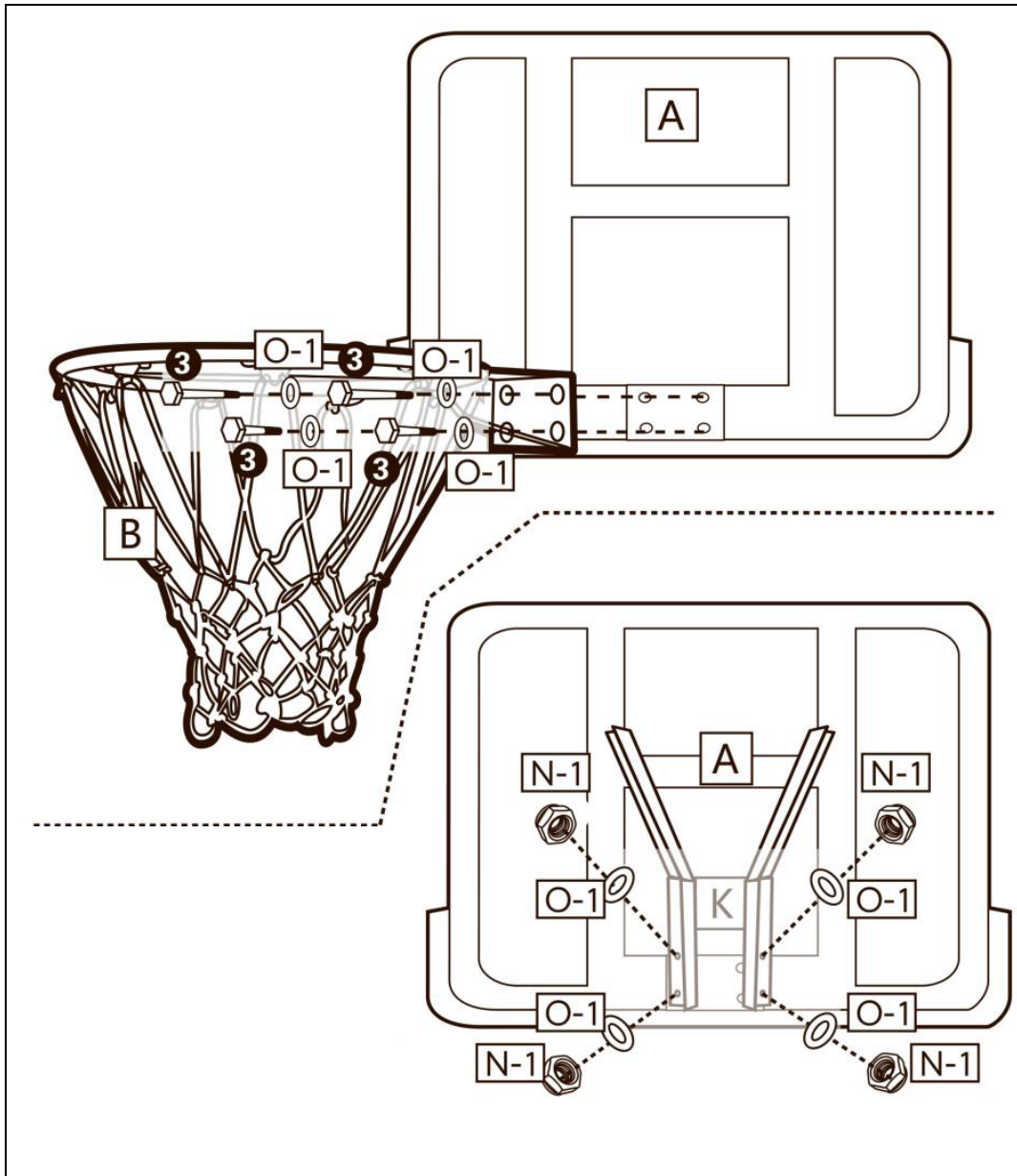

2. Montér nettet (B-2) på kurvens (B-1) kroge.

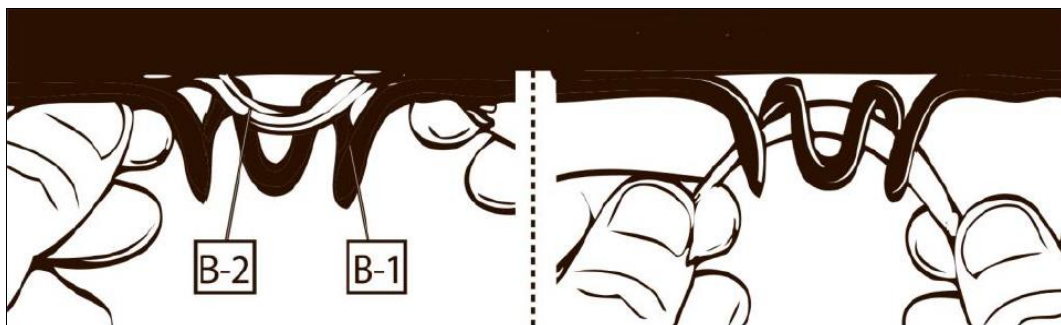

## Trin 3

1. Før toprøret (F) nedfra og op igennem det midterste rør (E). Spænd de to rør sammen med en bolt (6) og møtrik (I).

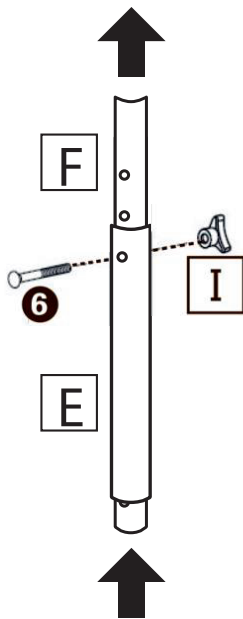

← **VIGTIGT!**

2. Montér det øverste rør (F) på beslaget (K) og spænd med bolte (5), skiver (O-2) og møtrikker (N-2).
3. Montér topdækslet (L) på toprøret (F).
4. Udfold stængerne på beslaget (K) og fastgør dem på bagpladen (A) med bolte (1) og skive (O-1).

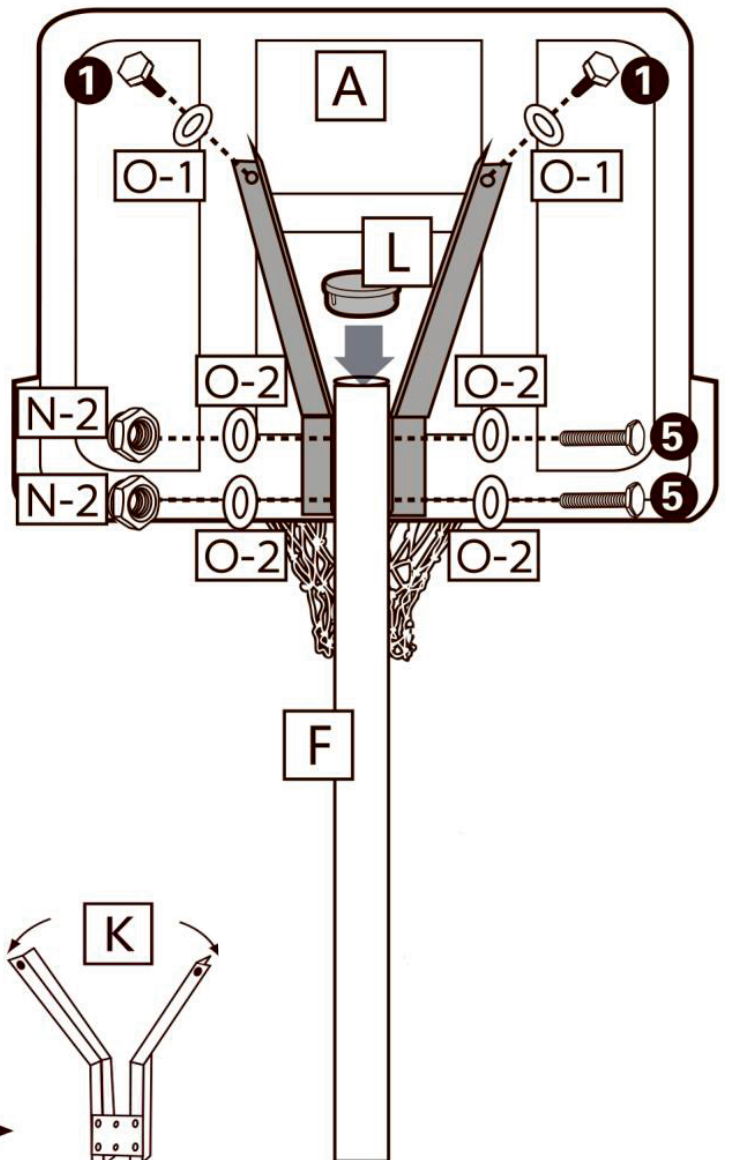

1. Sæt rør (D) og rør (E) sammen og spænd med bolt (4) og møtrik (N-2).
2. Højden kan efterfølgende justeres med bolt (6) og møtrik (I).

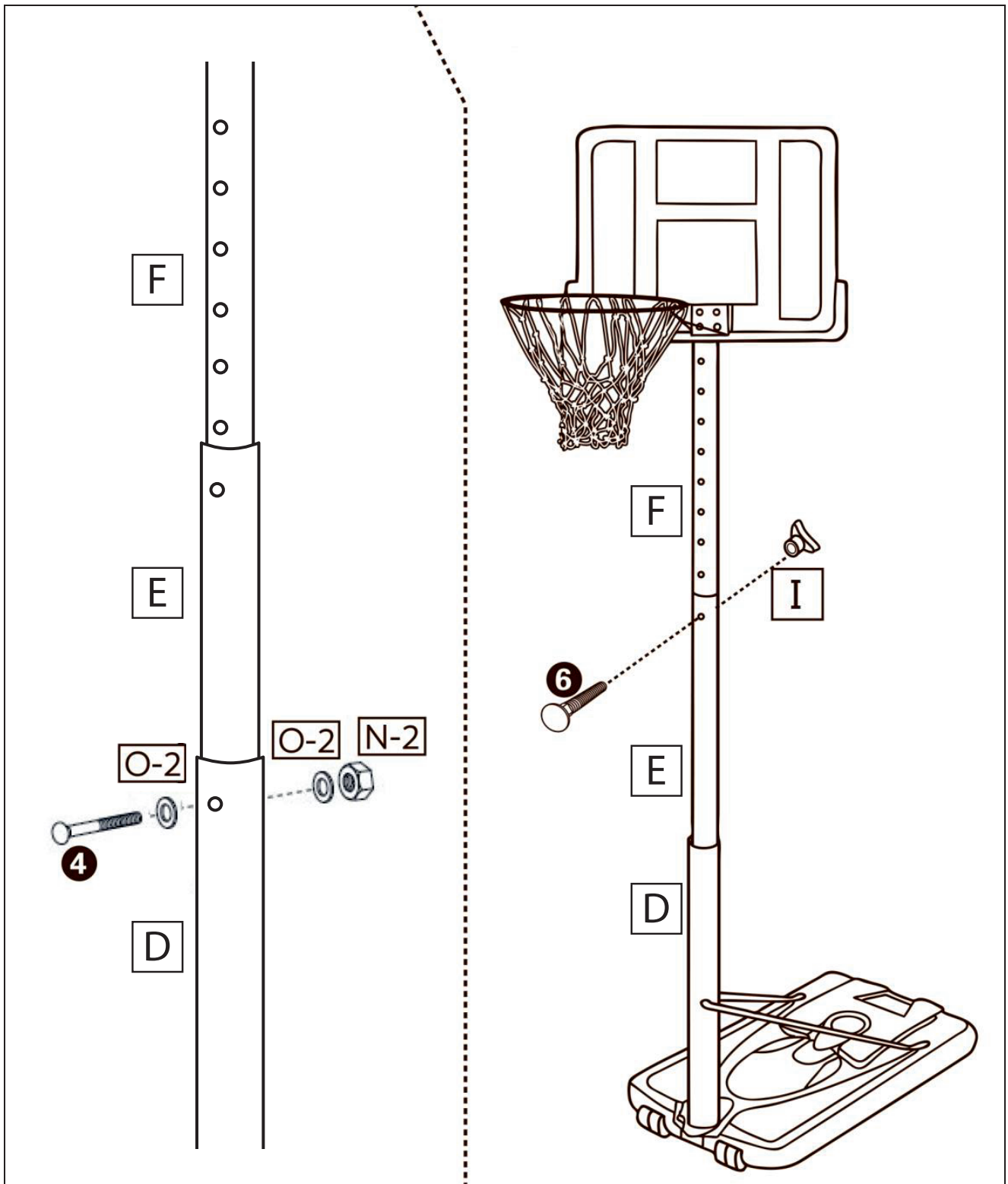



## Trin 5

**OBS!** Der skal være 2 personer til at påfylde sand i sandbasen. Brug ikke vand da dette vil sive ud eller frostspringe.

1. Placér basketballstanderen hvor den skal benyttes og afmonter låget til sandbasen.
2. Justér basketballstanderen til laveste højde og tilt standeren i 45 grader.
3. Påfyld derefter sand i sandbasen.
4. Når sandbasen er fyldt med sand, tiltes basketballstanderen på plads og resten af sandbasen fyldes med sand.

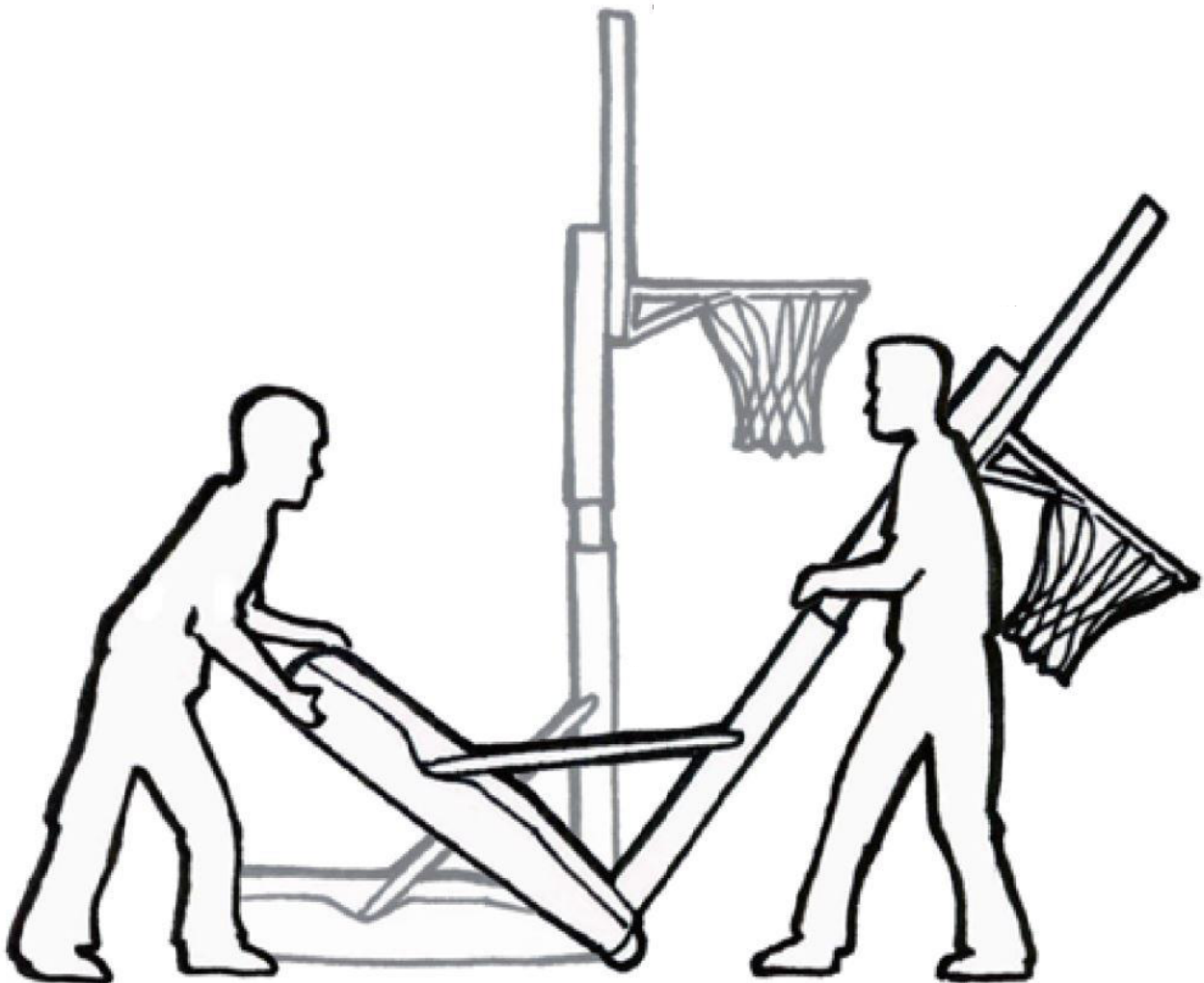

**ADVARSEL!** Hvis du ikke følger alle instruktioner og advarsler præcist kan det medføre alvorlig personskade.



**Bestplay A/S  
Knullen 22  
5260 Odense S  
Tlf. +45 70 22 72 92  
Danmark**



# Basketball stand LUX/LUX safe



 **WARNING**  
CHOKING HAZARD  
small parts  
Adult assembly required  
retain for future reference



## **Safety warning**

Read all instructions and complete all assembly before using.

When properly assembled and used as intended, this basketball stand is designed to provide many hours of training and playing enjoyment.

Inspect the basketball stand before every use. Make sure all parts are correctly and securely positioned and attached. Tighten any loose parts. Replace any worn, defective, or missing parts.

Never let children climb on the basketball stand as this can result in basketball stand tipping over causing serious injuries to the child.

Adult supervision is necessary at all times when the basketball stand is used by children. **WARNING!** The basketball stand can tip over in windy weather. Make sure to fasten it or moving it to a secure location if weather is turning windy/stormy.

The metal frame of the basketball stand can conduct electricity. Lights, extension cords, and all such electrical equipment must never be allowed to come in contact with the basketball stand.

## **Assembly**

Clearance from all nearby objects is essential. Place the basketball stand away from walls, structures and fences. Maintain a clear space on all sides of the basketball stand.

Adequate overhead clearance is essential. Provide clearance for wires, tree limbs, and other possible obstacles.

Never set up the basketball stand in heavy rain, wind or storm conditions, especially storms. When moving the assembled basketball stand have minimum two people to lift the basketball stand off the ground with even weight distribution.

Place the basketball stand on an even surface before use.

Secure the basketball stand against unauthorized and unsupervised use.

## **Maintenance**

Inspect the basketball stand before each use and replace any torn, defective, or missing parts. The following conditions could present potential hazards:

1. Missing, wrongly positioned, or insecurely attached pipes or basket.
2. Punctures, frays, tears, or holes worn in the basketball stand.
3. A bent or broken pipe or support system.
4. Sharp points sticking out of the pipe or basket.
5. Loosened or missing hardware.

## Before assembling

1. It is recommended to be at least two persons to assemble this product.
2. Do not leave the basketball stand without support before the sandbase has been filled with sand.
3. Do not use water, as this can leak. In cold weather water may freeze and damage the base.
4. This basketball stand can **not** be used for dunks.

## Packing list

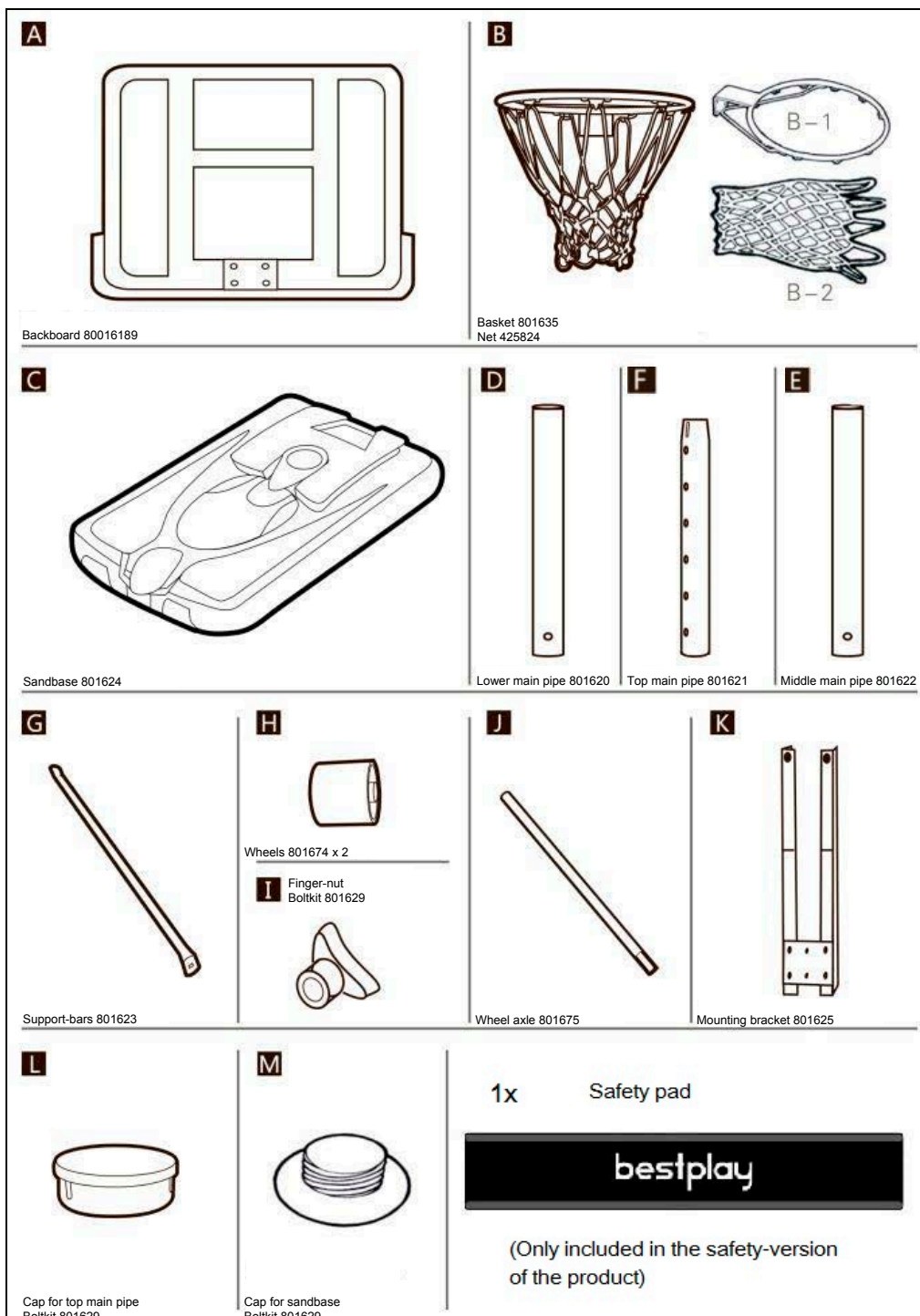

Boltkit 801629

**N-1** M8



x6

**N-2** M10



x3

**O-1** M8

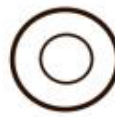

x16

**O-2** M10



x6

M8 x16mm



**1**

x4

M8 x20mm



**2**

x2

M8 x40mm



**3**

x4

M10 x85mm



**4**

x1

M10 x90mm



**5**

x2

M8 x 90mm



**6**

x1

Recommended tool

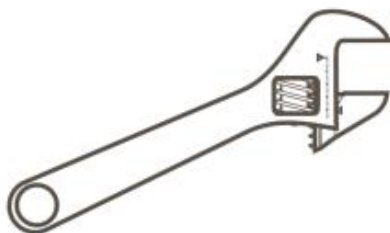



## Assembly

### Step 1

1. Insert wheel axle (J) through the two wheels (H) and the lower main pipe (D) on the sandbase (C).
2. Fasten the two support-bars (G) onto the lower main pipe (D) with bolts (1) and washers (O-1).
3. Now fasten the other end of the support-bars (G) onto the sandbase (C) using bolts (2), washers (O-1) and nuts (N-1).

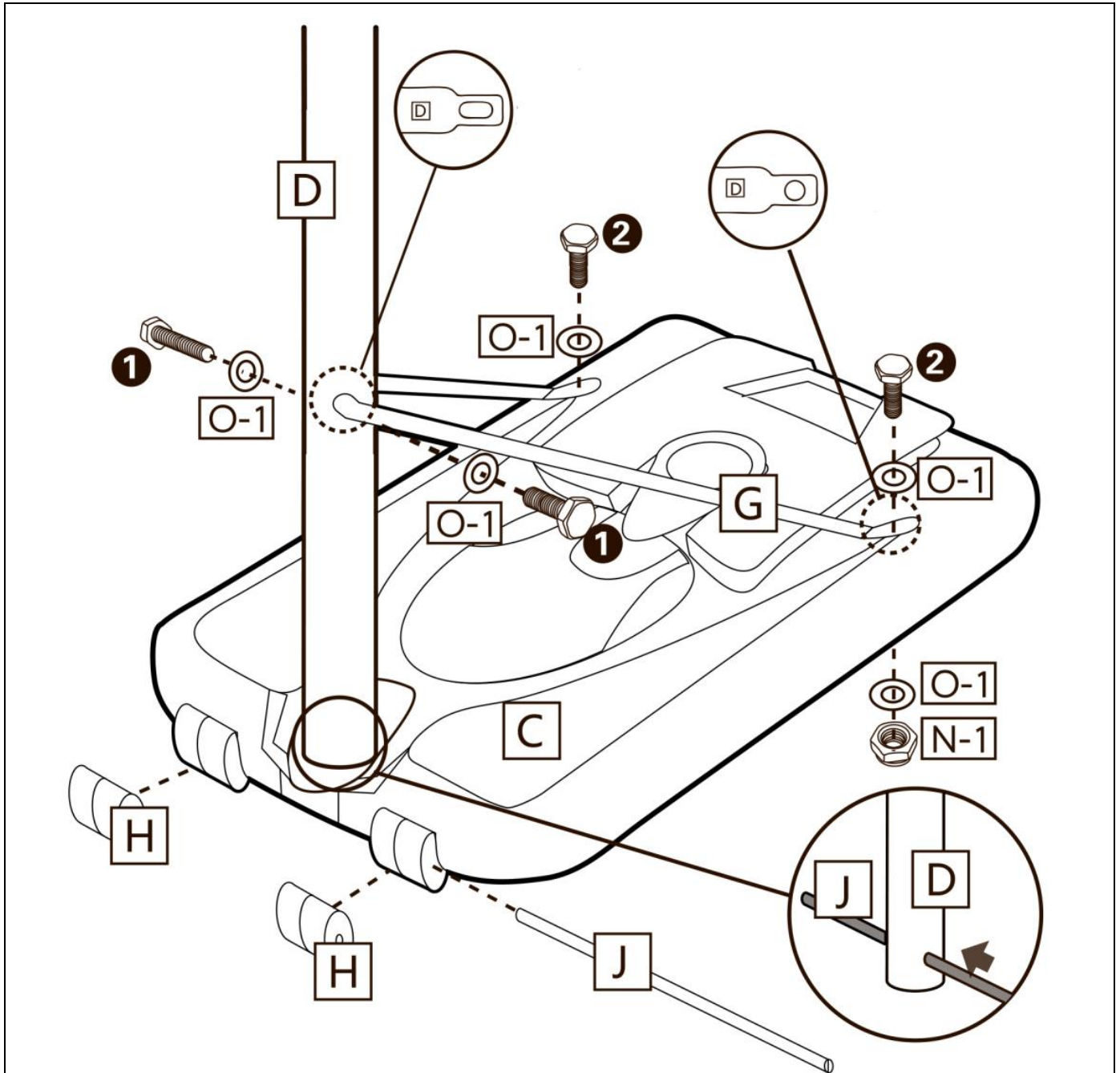

**Step 2**

1. Fasten the back mounting bracket (K) by inserting bolts (3) through washers (O-1) and the holes in the basket (B) on the back-board (A). On the backside let the same bolts through the back mounting bracket (K) as well and fasten them with washers (O-1) and nuts (N-1).

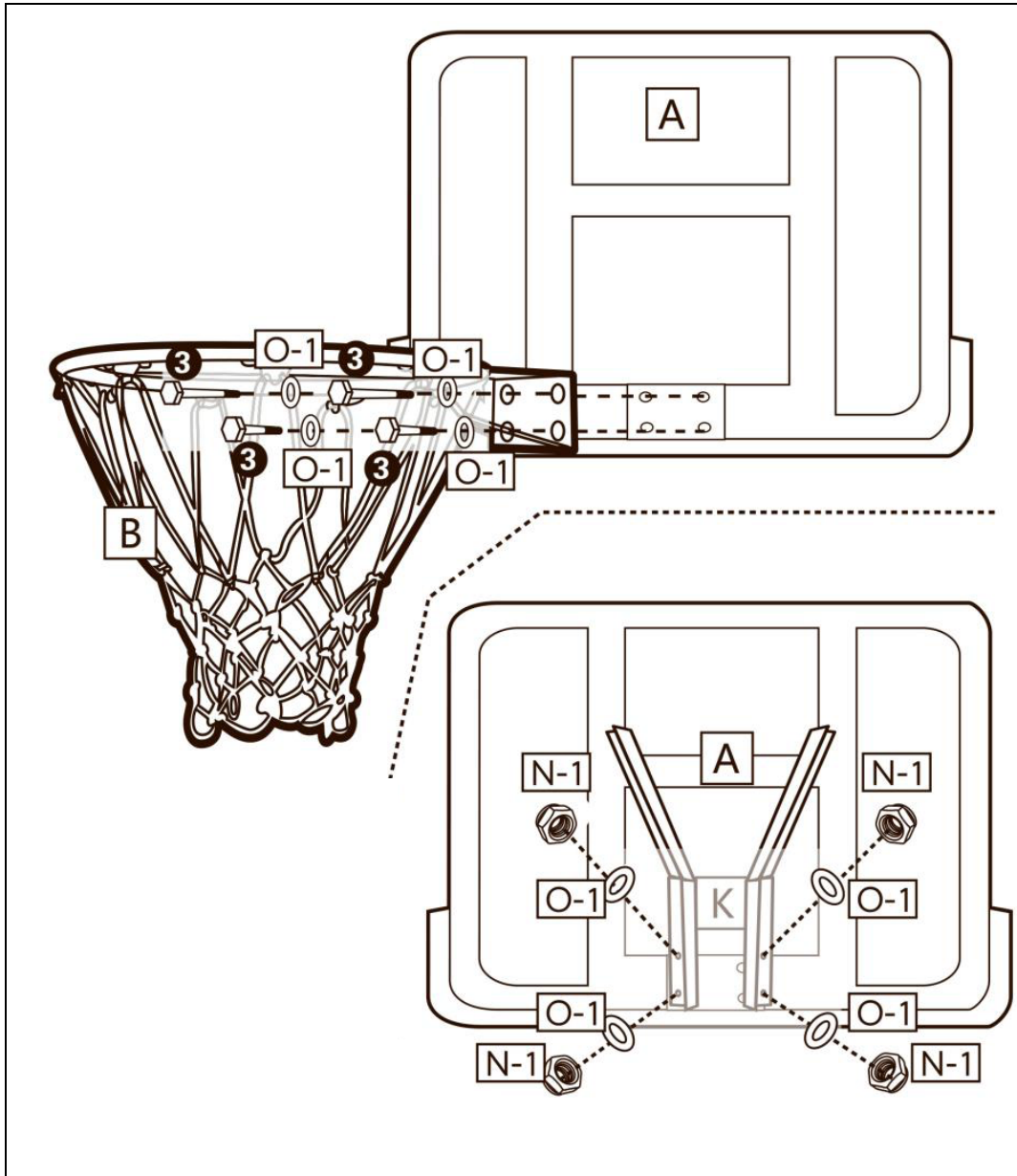

2. Fasten the net (B-2) onto the baskets (B-1) hooks.

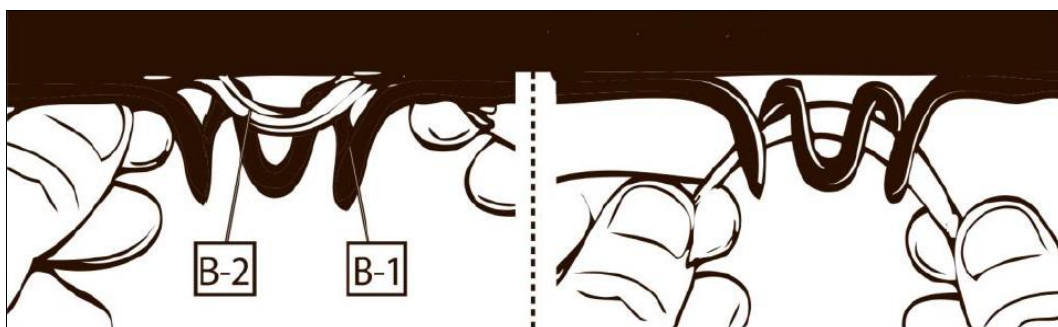

## Step 3

1. Insert the top main pipe (F) from below and through the middle main pipe (E). Tighten the two pipes with bolts (6) and finger-nut (I).

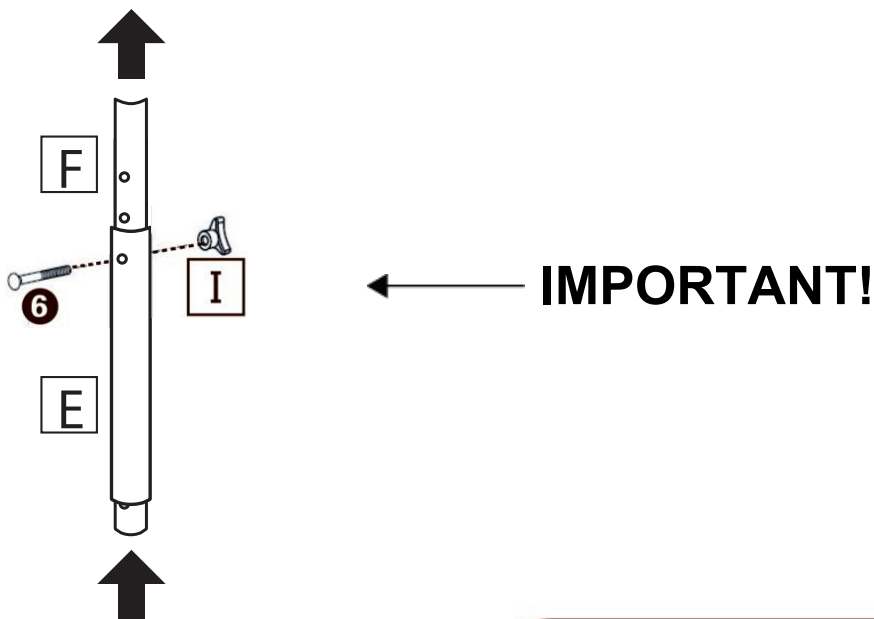

2. After (F) has been put through (E), the back mounting bracket can be fastened onto top main pipe (F). This is done by placing back mounting bracket (K) onto top main pipe (F) and fastening it using bolts (5), washers (O-2) and nuts (N-2).
3. Place the cap (L) onto the top main pipe (F).
4. Bend the bars on the back mounting bracket (K) as shown on the drawing and fasten them to the backboard (A) using bolts (1) and washers (O-1).

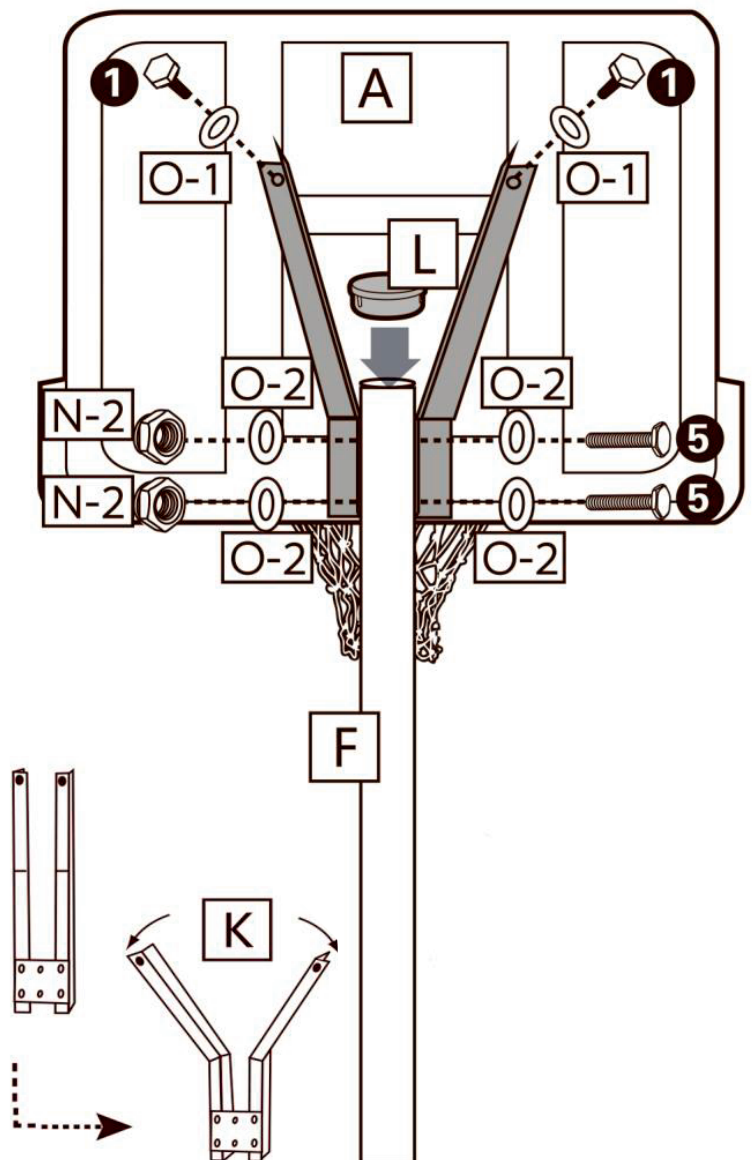

## Step 4

1. Now assemble the upper part with the base by putting middle main pipe (E) into lower main pipe (D). Tighten with bolts (4) and nuts (N-2).
2. The height of the basketball stand can now easily be adjusted using the bolt (6) and finger-nut (I). However, it is recommended to be two adults and tipping it over to prevent the top to suddenly drop when nuts are released.

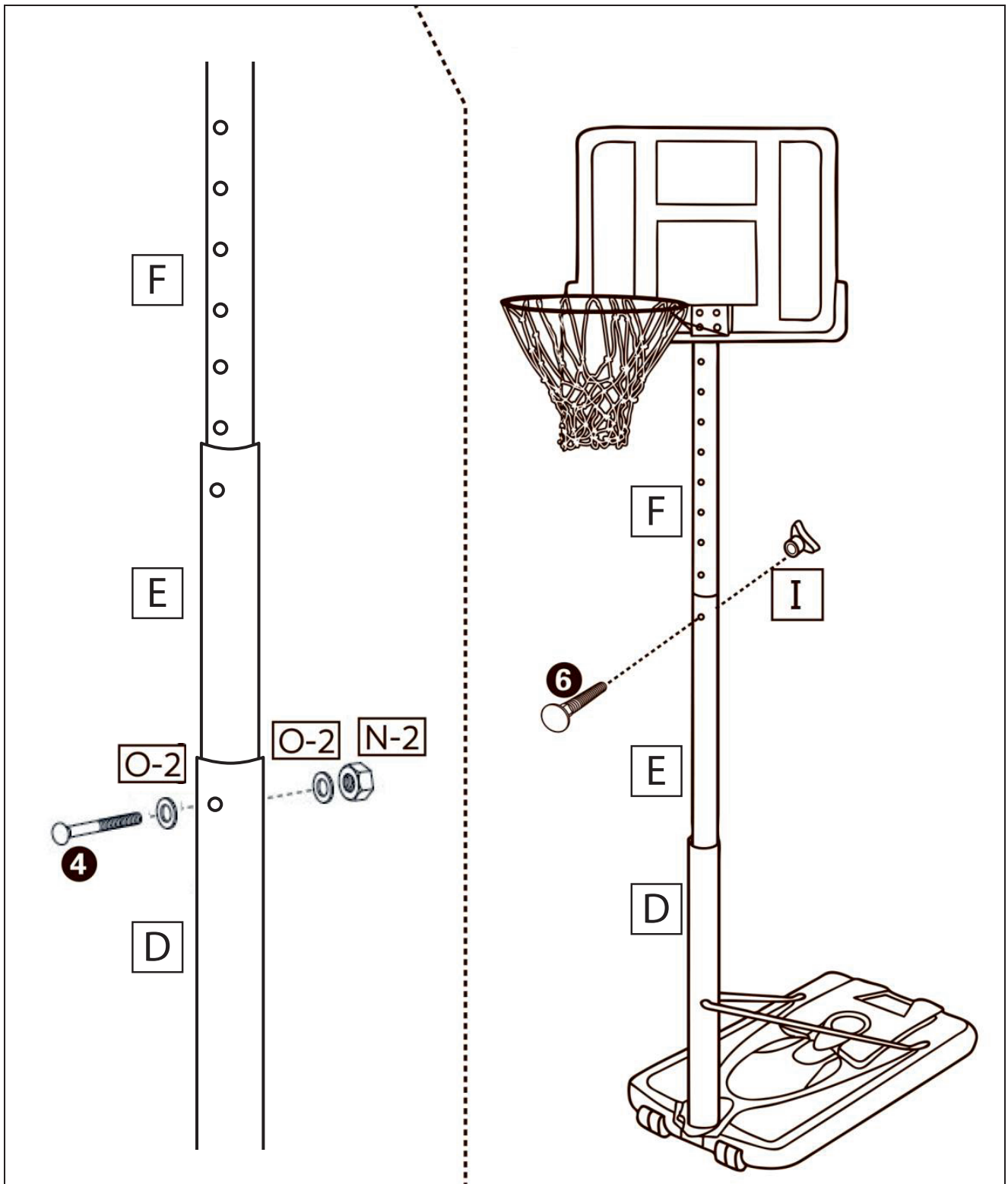

## Step 5

**Attention!** It is recommended to be two persons when filling the base with sand. Do not use water, as it can leak. In cold weater the freezing may cause damage if the base is filled with water.

1. Place the basketball stand at a suitable location and unscrew the lid of the sandbase.
2. Adjust the basketball stand to lowest setting and tilt the stand 45 degrees, as shown on picture below. It is recomended to be two adults.
3. Fill the sandbase with sand.
4. When the base is seemingly full of sand, tilt the basketball stand back down and pour more sand into the base.

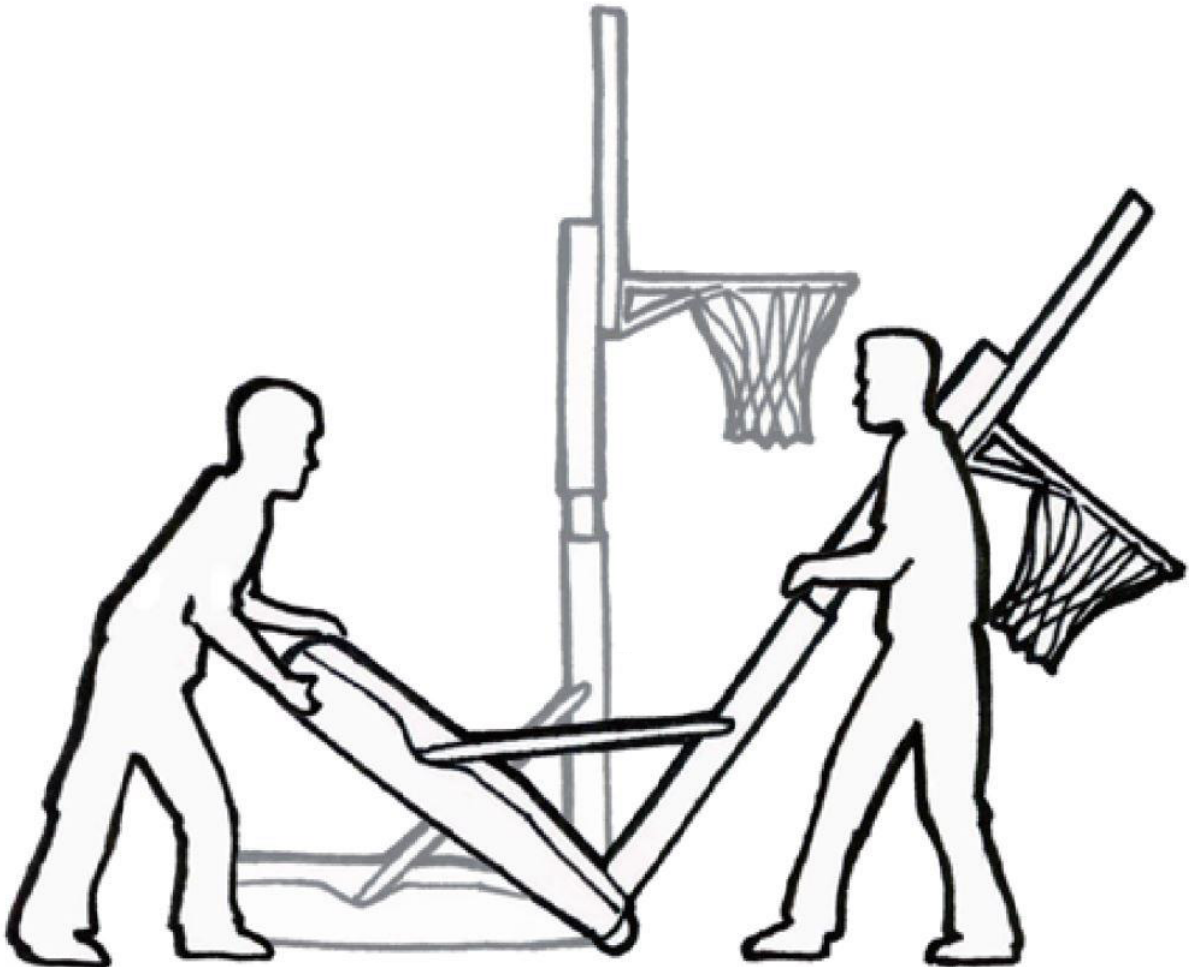

**WARNING!** Failure to follow the instructions may cause bodily damage.



**Bestplay A/S  
Knullen 22  
5260 Odense S  
Tlf. +45 70 22 72 92  
Denmark**