

Swagger™

S-M3E

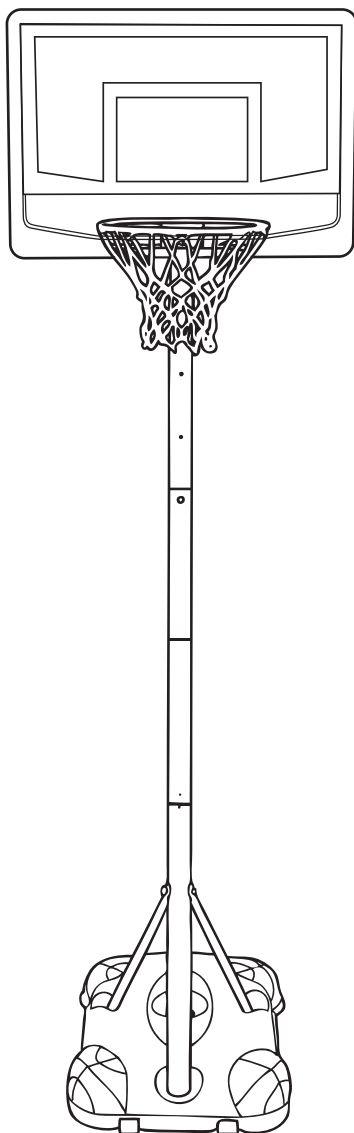



Swager™

Før opsamling

1. Der skal være 2 personer til at opsamle standen.
2. Lad ikke standen stå frit, før den er påfyldt sand.
3. Brug ikke vand, da dette vil sive ud af basen.
4. Denne stander er ikke godkendt til at ”dunke” i.

Indhold

A Bagplade 80017453

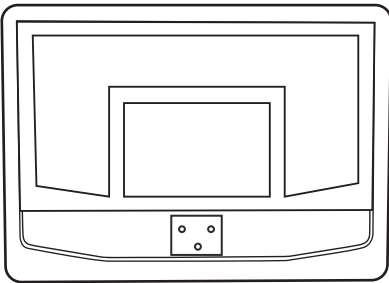

x1

B Ring 80017454
Net 80017455



x1



B-1

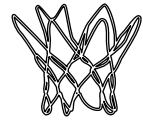

B-2

C Sandbase 80017456

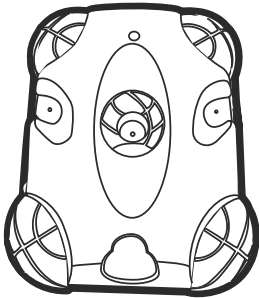

x1

D Nederste rør
80017457

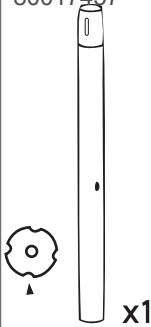

x1

E Midterste rør
80017457

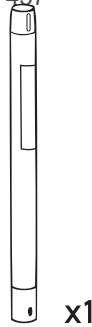

x1

EA Midterste rør
80017457



x1

F Top rør
80017457



x1

G Støttearm
80017457

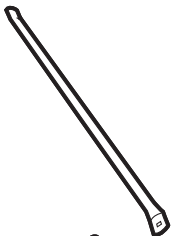

x2

H Tværstang
80017458



x2

I Beslag
80017458

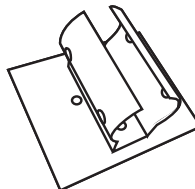

x1

J Hjul 80017458

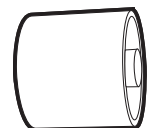

x2

K Fingerskrue
80017455

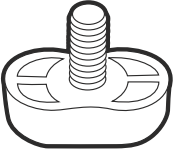

x1

L Fingerskrue
80017455



x1

M Dæksel til toprør
80017455



x1

N Dæksel
80017455



x1

Q-1 Lock Nut



M8 x6

M8 x 65mm



1

x1

Q-2 Lock Nut



M6 x3

M8 x 60mm

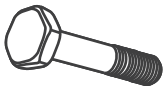

2

x2

R-1 Washer

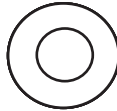

M8 x9

M6 x 30mm



3

x3

R-2 Washer



M6 x6

M8 x 65mm

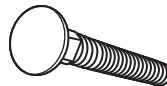

4

x1

S Nut



M5 x1

M8 x 20mm



5

x2

M5 x 16mm

M8 x 65mm

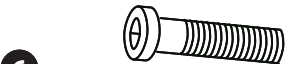

6

x1

M5 x 75mm



7

x1



8

x2

Anbefalet værktøj

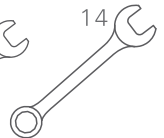
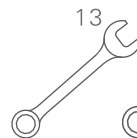
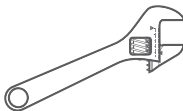
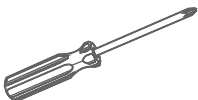

Opsamling

Step 1

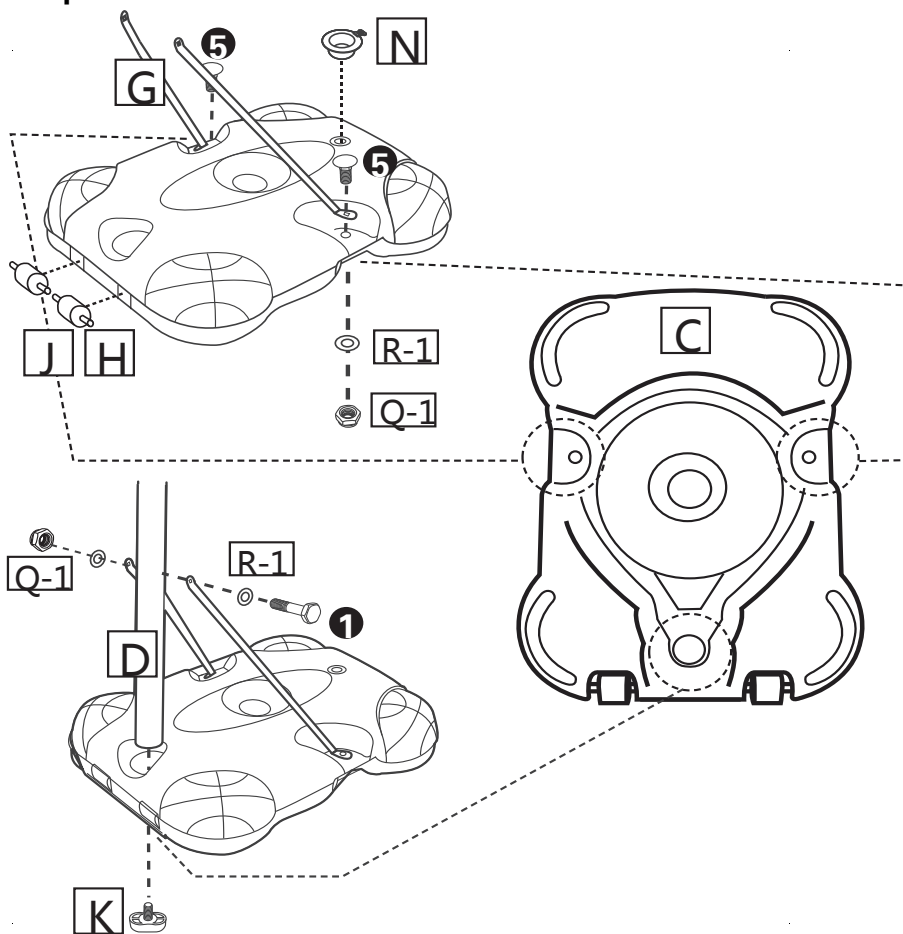

1. Montér det nederste rør (D) på sandbasen (C). Spænd med møtrik (K)
2. Fastgør de 2 støttestænger (G) på det nederste rør (D)
3. Benyt bolte (1), skiver (R-1) og møtrikker (Q-1).
4. Spænd derefter den anden ende fast i sandbasen (C), men bolte (5), skiver (R-1) og møtrikker (Q-1).

Step 2

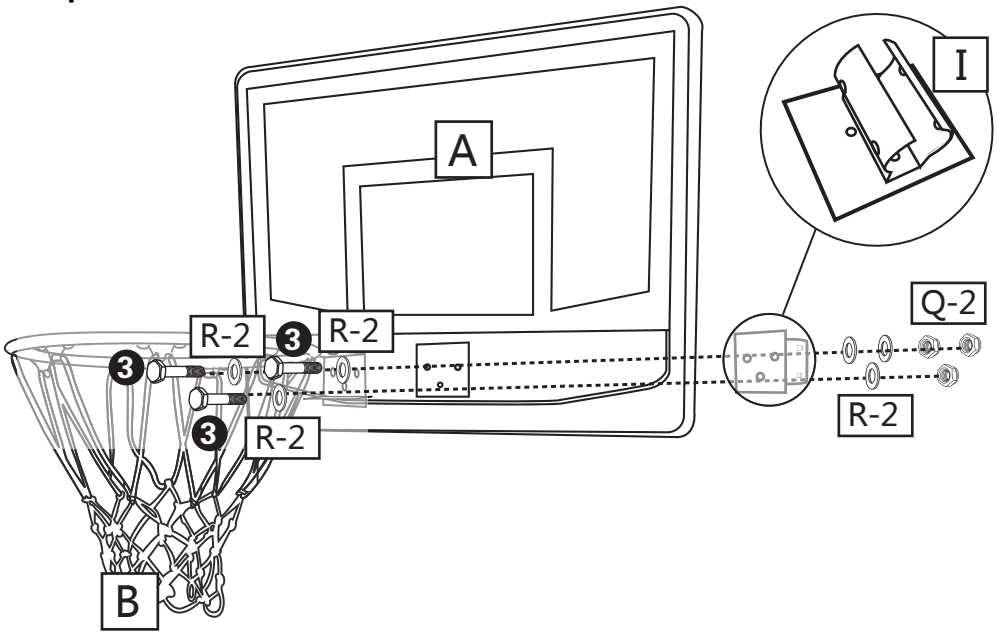

-
1. Fastgør beslaget (I) og basketkurven (B) på bagpladen (A). Brug tre bolte (3), 6 skiver (R-2) og tre møtrikker (Q-2).



2. Nettet (B-1) hæftes på kurvens øverste kant (B-2) ved at trække nettet over og omkring løkken på kurven. Gentag for resten af løkkerne på kurven.

Step 3

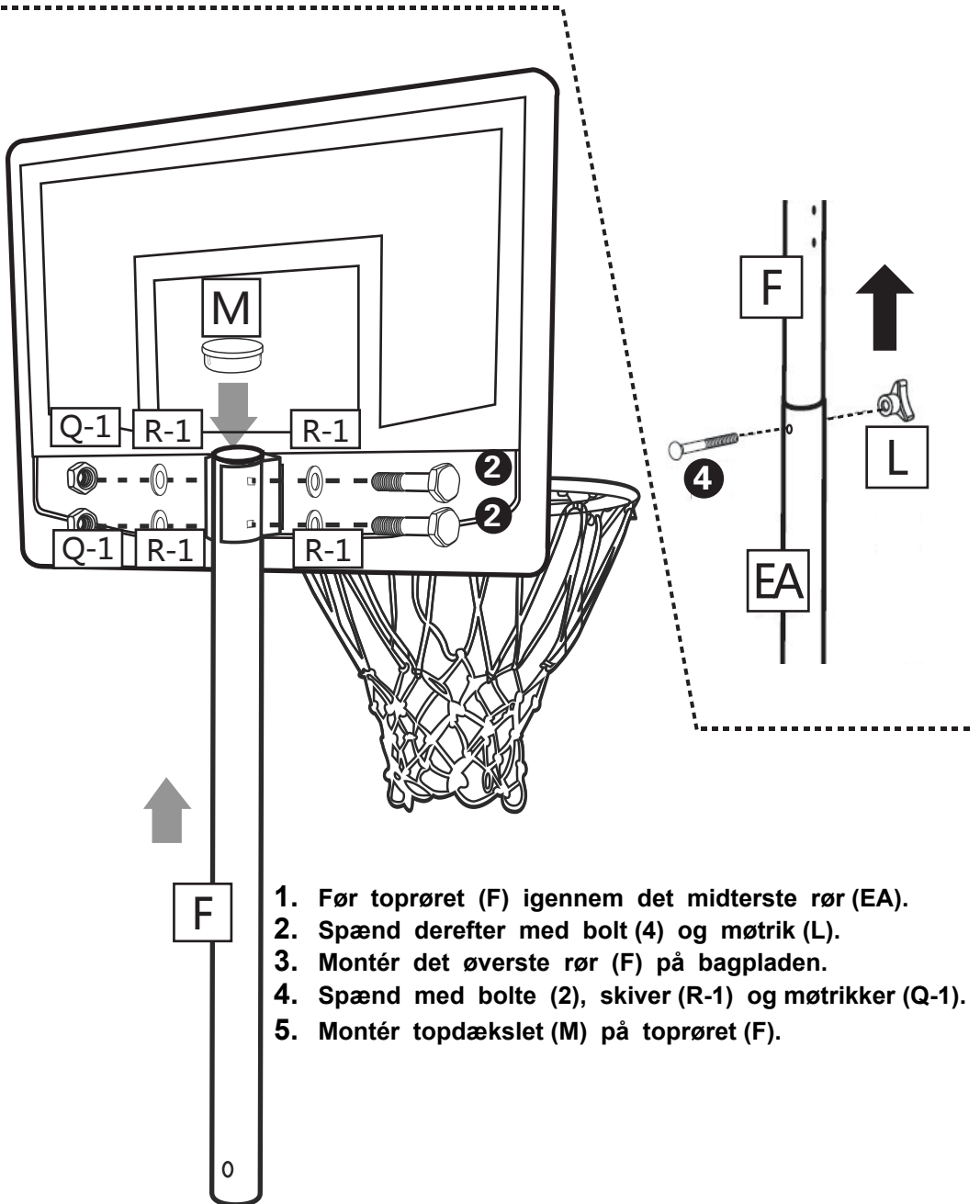

1. Før topøret (F) igennem det midterste rør (EA).
2. Spænd derefter med bolt (4) og møtrik (L).
3. Montér det øverste rør (F) på bagpladen.
4. Spænd med bolte (2), skiver (R-1) og møtrikker (Q-1).
5. Montér topdækslet (M) på topøret (F).

Step 4

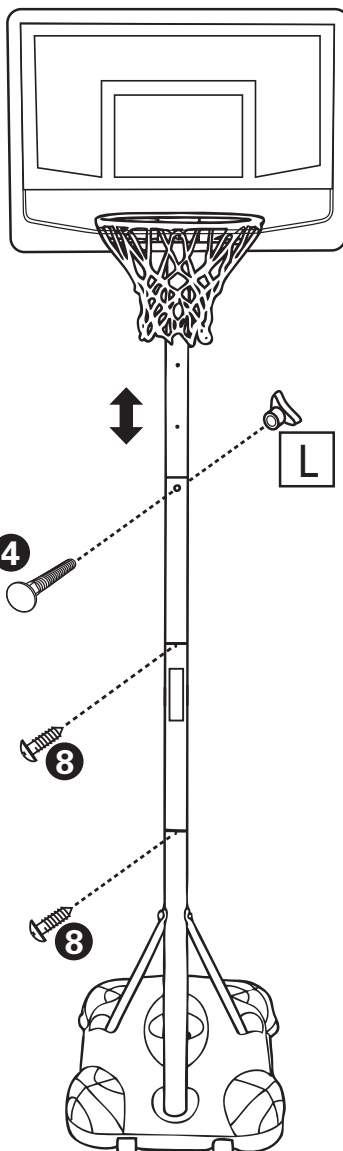
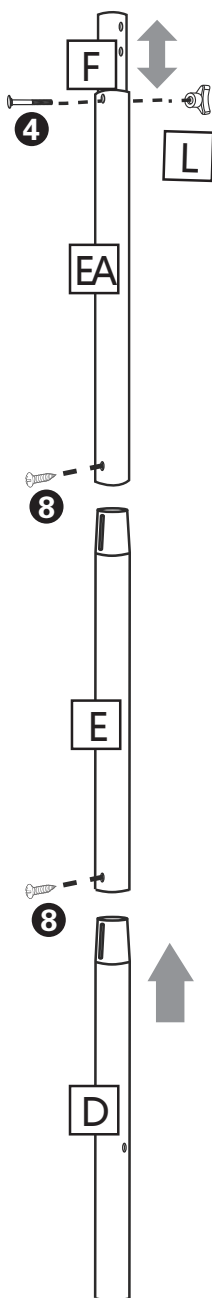

1. Før det midterste rør (EA) ned i det midterste rør (E). Spænd med skrue (8)
2. Højden kan efterfølgende justeres med bolt (4) og møtrik (L).

Step 5

Der skal være 2 personer til at påfylde sand i basen. Brug ikke vand, da dette vil sive ud og kan frostspringe.

1. Placér standeren der, hvor den skal benyttes og afmonter låget til basen.
2. Juster standeren til laveste højde og tilt standeren i 45 grader. Påfyld derefter sand i basen. Når basen er fyldt med sand, tiltes standeren på plads og resten af basen fyldes med sand.

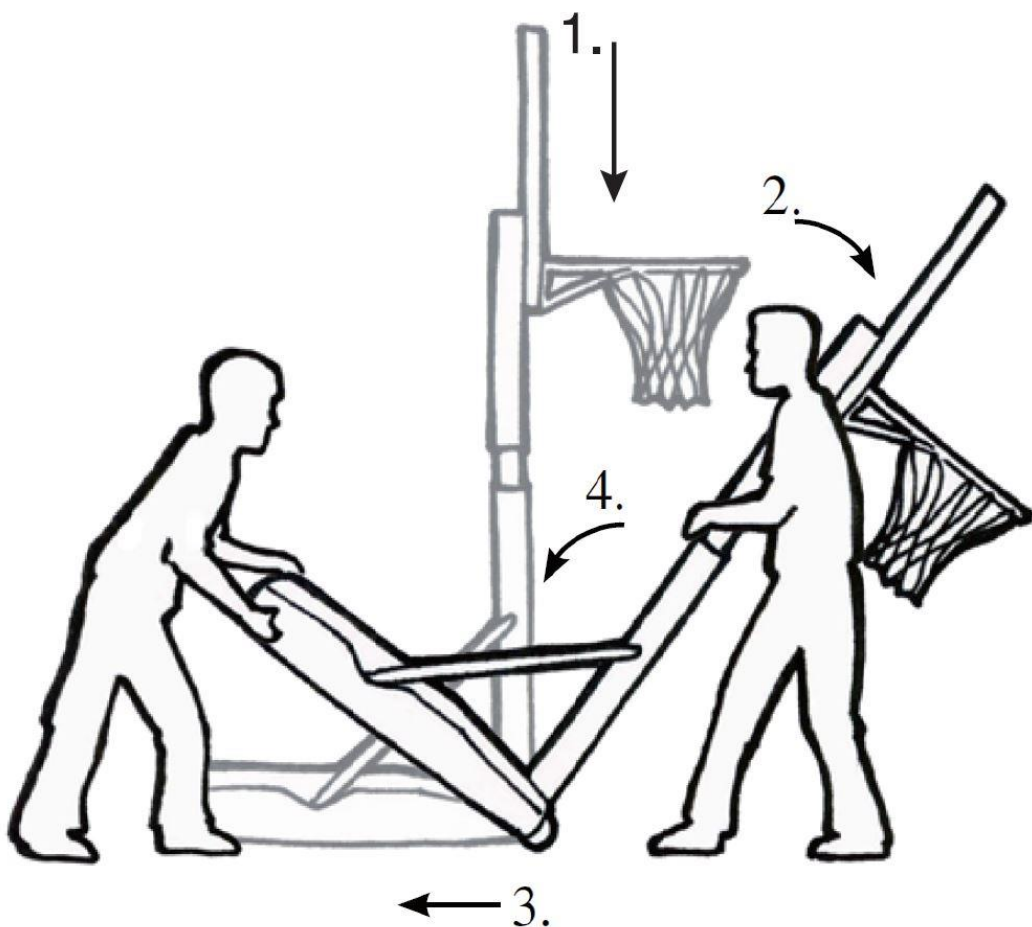

ADVARSEL! Hvis du ikke følger alle instruktioner og advarsler præcist, kan det medføre alvorlig personskade.